

INSTALLATION INSTRUCTIONS

4" OVAL STRAIGHT SIDE BAR
 99-09 1500-2500-3500 SILVERADO/SIERRA EXT CAB
 PART NUMBER

PARTS LIST:

1	Passenger Side Bar	6	10-1.50mm x 30mm Hex Head Bolts
1	Driver Side Bar	4	10mm Hex Nuts
1	Passenger Side Front Mounting Bracket	6	10mm Lock Washers
1	Driver Side Front Mounting Bracket	10	10mm ID x 20mm OD x 1.5mm Flat Washers
1	Passenger Side Center Mounting Bracket	2	10mm Nut Plates
1	Driver Side Center Mounting Bracket	12	8-1.25mm x 20mm Hex Head Bolts
1	Passenger Side Rear Mounting Bracket	12	8mm Lock Washers
1	Driver Side Rear Mounting Bracket	12	8mm ID x 22mm OD x 1.5mm Flat Washers
1	Passenger Side Front Support Bracket	2	12-1.75mm x 30mm Hex Head Bolts
1	Driver Side Front Support Bracket	2	12mm Hex Nuts
2	Center Support Brackets	4	12mm ID x 29mm x 3mm Flat Washers
		2	12mm Lock Washers

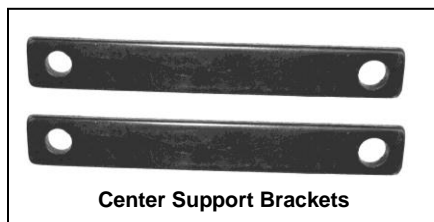
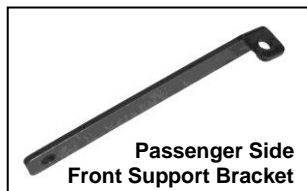

PROCEDURE:

1. **REMOVE CONTENTS FROM BOX. VERIFY ALL PARTS ARE PRESENT. READ INSTRUCTIONS CAREFULLY BEFORE STARTING INSTALLATION.**
2. From underside of vehicle remove front, center, and rear body mount bolts. Do not remove bushings.
3. Hang driver side front, center and rear Mounting Brackets into position by partially threading factory body mounting bolts back into body mounts **(Figure 1)**.
4. Locate the two factory holes in the bottom of the frame towards the front of the vehicle. Insert (1) Nut Plate through oval hole and orient Nut Plate towards the front round hole **(Figure 2)**.
5. Attach driver side front Support Bracket to already inserted Nut Plate by partially threading (1) 10mm x 30mm Hex Head Bolt, (1) 10mm Lock washer, and (1) 10mm Flat Washer **(Figure 3 & 4)**.

1500 Models:

Attach opposite side of driver side front Support Bracket to outside hole in the Mounting Bracket using the included (1) 10mm x 30mm Hex Head Bolt, (1) 10mm Hex Nut, (1) 10mm Lock Washer, and (2) 10mm Flat Washers **(Figure 3)**. Do not tighten at this time.

2500 Models:

Note that the Support Bracket will not reach the Mounting Bracket **(Figure 3)**. Tighten the Support Bracket to Nut Plate in the frame. Carefully push up on the Support Bracket until it reaches the inside hole in the Mounting Bracket **(Figure 5)**. Attach opposite side of driver side front Support Bracket to inside hole in the Mounting Bracket using the included (1) 10mm x 30mm Hex Head Bolt, (1) 10mm Hex Nut, (1) 10mm Lock Washer, and (2) 10mm Flat Washers **(Figure 6)**. Do not tighten at this time.

1500 and 2500 Models

6. From the inner side of the center body mount, place (1) Center Support Bracket onto front side of the body mount. Attach Center Support Bracket to body mount using the included (1) 12-1.75mm x 30mm Hex Head Bolt, (1) 12mm Hex Nut, (1) 12mm Lock Washer, and (2) 12mm Flat Washers **(Figure 7 & 8)**. Do not tighten at this time. **NOTE:** Larger hole on the Center Support Bracket mounts to body mount.
7. Attach opposite side of Center Support Bracket to center Mounting Bracket using the included (1) 10-1.50mm x 25mm Hex Head Bolts, (1) 10mm Hex Nuts, (1) 10mm Lock Washers, and (2) 10mm Flat Washers **(Figure 7 & 8)**. Do not tighten at this time.
8. Carefully position Driver Side Bar onto Mounting Brackets. Attach Side Bar to Mounting Brackets using the included (6) 8-1.25mm x 20mm Hex Head Bolts, (6) 8mm Lock Washers, and (6) 8mm Flat Washers **(Figure 9)**. Do not tighten at this time.
9. Level and adjust Side Bar, then tighten all hardware at this time.
10. Repeat steps 2-9 for passenger Side Bar.
11. Do periodic inspections to the installation to make sure that all hardware is secure and tight.

To protect your investment, wax this product after installing. Regular waxing is recommended to add a protective layer over the finish. Do not use any type of polish or wax that may contain abrasives that could damage the finish.

For stainless steel: Aluminum polish may be used to polish small scratches and scuffs on the finish. Mild soap may be used also to clean the Sidebar.

For gloss black finishes: Mild soap may be used to clean the Sidebar.

Driver Side Installation Pictured

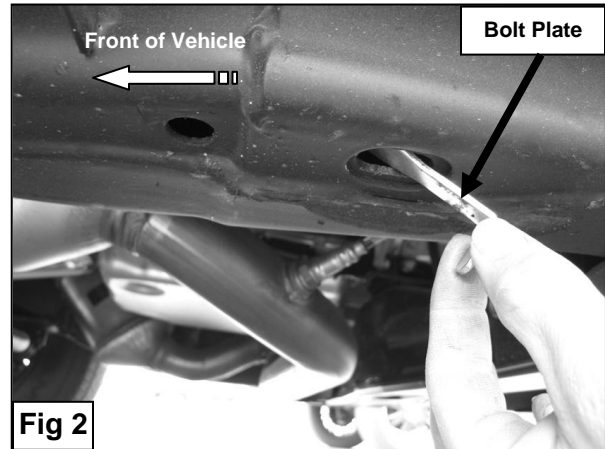
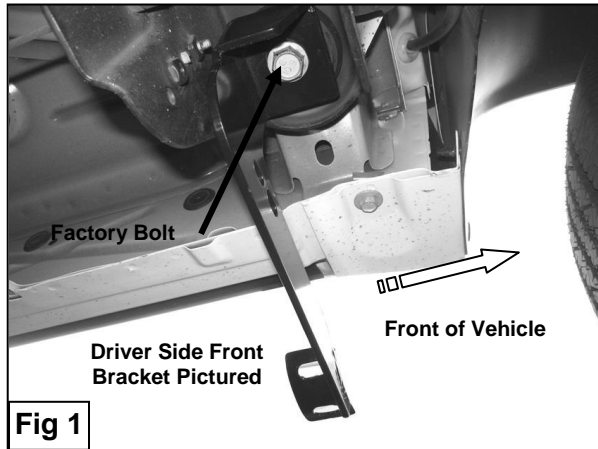

1500 Model Front Installation Pictured

10mm x 30mm Hex Bolt,
10mm Hex Nut
10mm Flat Washers
10mm Lock Washer

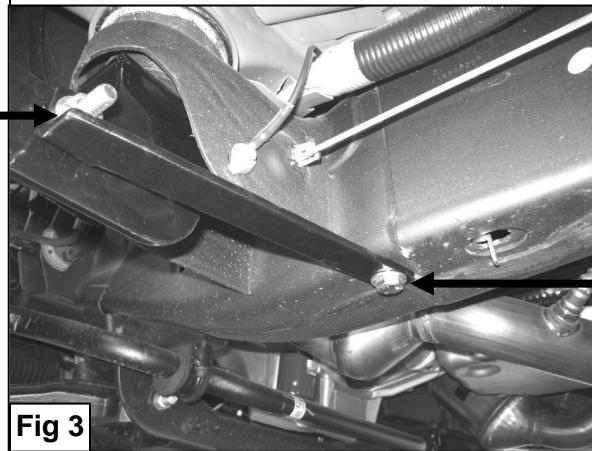

10mm Nut Plate
10mm x 30mm Hex Bolt
10mm Lock Washer
10mm Flat Washer

2500 Model Front Installation Pictured

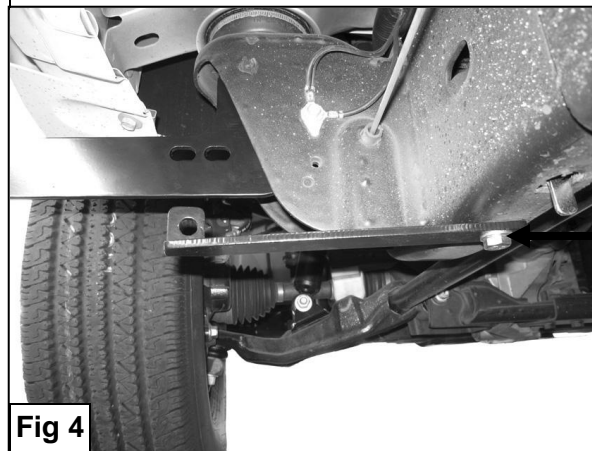

10mm Nut Plate
10mm x 30mm Hex Bolt
10mm Lock Washer
10mm Flat Washer

2500 Model Front Installation Pictured

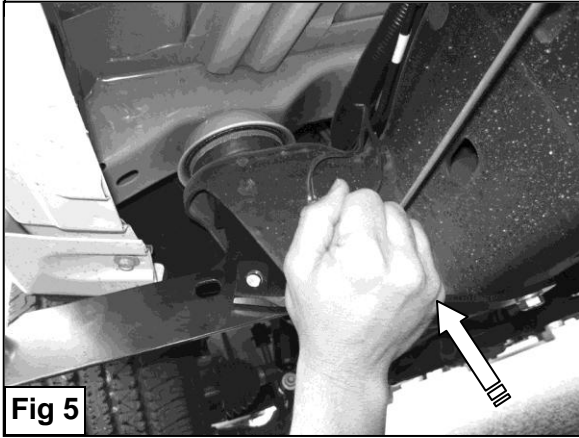

2500 Model Front Installation Pictured



- 10mm x 30mm Hex Bolt
- 10mm Flat Washers
- 10mm Lock Washer
- 10mm Hex Nut

1500 Model Center Installation Pictured

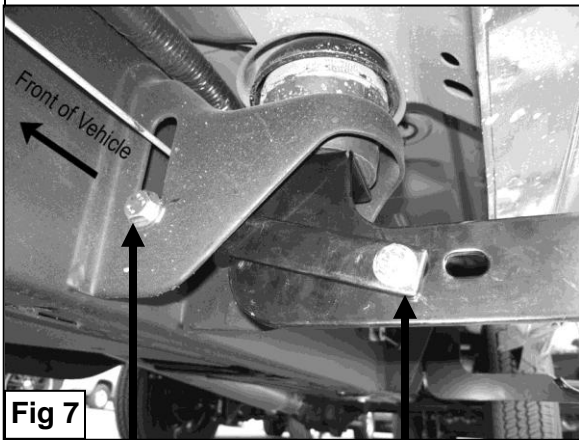

- 12mm x 30mm Hex Bolt
- 12mm Hex Nut
- 12mm Flat Washers
- 12mm Lock Washer

- 10mm x 30mm Hex Bolt,
- 10mm Hex Nut
- 10mm Flat Washers
- 10mm Lock Washer

2500 Model Center Installation Pictured

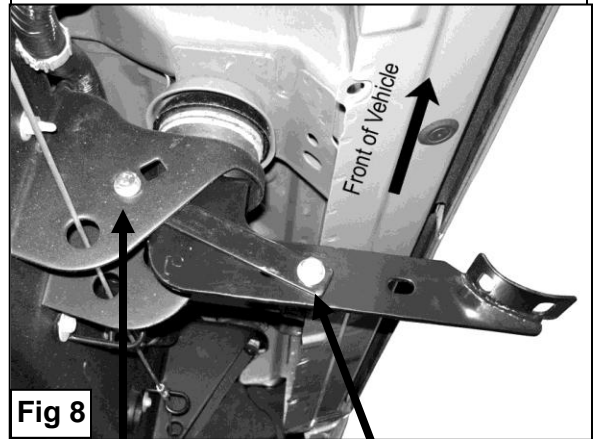

- 12mm x 30mm Hex Bolt
- 12mm Hex Nut
- 12mm Flat Washers
- 12mm Lock Washer

- 10mm x 30mm Hex Bolt,
- 10mm Hex Nut
- 10mm Flat Washers
- 10mm Lock Washer

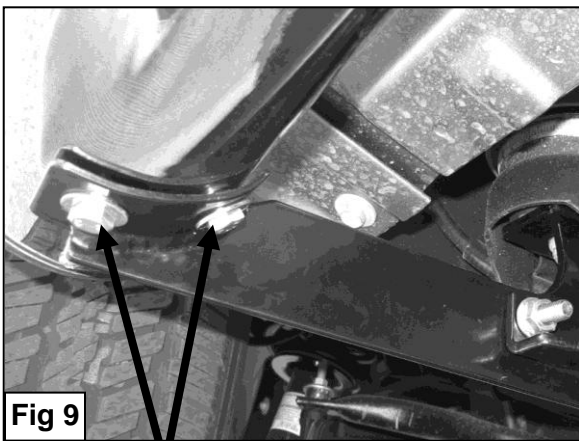

- 8mm x 20mm Hex Bolt,
- 8mm Lock Washer, &
- 10mm Flat Washer



IMPORTANT ALERT: GM uses a very strong thread-locking compound on all body bolts. Use of an air assisted impact ratchet can cause damage to the threads on factory body mount bolts and the internal nut assembly because of this thread locking compound. We only recommend the use of hand tools to slowly remove and reinstall body mount bolts on all GM vehicles.

PROCEDURE:

CRITICAL INFORMATION: If during the removal process, it becomes increasingly difficult to unscrew the body mount bolt with hand tools, tighten the bolt several rotations to clear the thread locking compound from the threads, then reverse direction and continue to unscrew until the body mount bolt is out. Repeat this process as necessary on all GM body mount bolts. Use of an appropriate anti-seize compound is highly recommended for re-installation. Tighten body mount bolt to factory torque specifications for your particular model year.

